

Data Sheet



Article number: 03508030

Description: Fluro Rod end GE 30FW-2RS

Measures

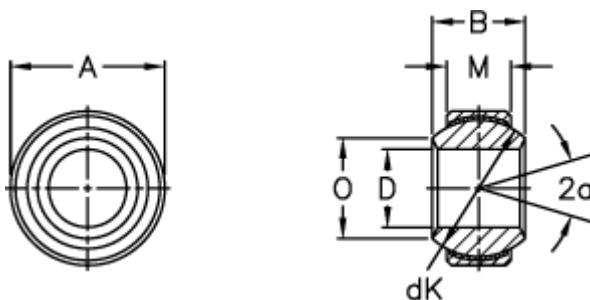

A	= 55 0 -0,013	Tilt angle = 17
B	= 32	Weight = 280
D	= 30 0 -0,010	
dK	= 47	
Dynamic load C (kN)	= 140	
M	= 20	
O	= 34.4	
Static load C0 (kN)	= 280	